



● Specifications

Nominal Voltage		12V
Rated Capacity (10 hour rate)		33Ah
Dimensions	Total Height	180±2mm(7.08 inches)
	Height	159±2mm(6.25 inches)
	Length	195±2mm(7.68 inches)
	Width	130±2mm(5.12 inches)
Weight Approx		10.3kg(22.76 lbs)±4%

● Characteristics

Capacity 25°C(77°F)	10 hour rate(3.3A) 5 hour rate(5.88A) 1 hour rate(20.5A)	33.0 AH 29.4AH 20.5AH
Internal Resistance	Full charged Battery at 25°C(77°F)	10m Ω
Capacity affected by Temperature (10hour rate)	40°C(104°F)	102%
	25°C(77°F)	100%
	0°C(32°F)	85%
	-15°C(5°F)	65%
Self-Discharge at 25°C(77°F)	Capacity after 3 month storage	91%
	Capacity after 6 month storage	82%
	Capacity after 12 month storage	64%
Charge (constant voltage)	Cycle	Initial Charging Current Less than 9.9 A Voltage 14.50-14.90V
	Float	Voltage 13.50-13.80V

● Applications

- Electric tools
- Electric toys
- Emergency lighting
- Electronic instruments
- Medical equipment
- Alarm and security systems
- Solar power systems
- Wind power systems
- Telecommunication equipments
- Uninterruptible power supplies

● Outer Dimensions (mm)

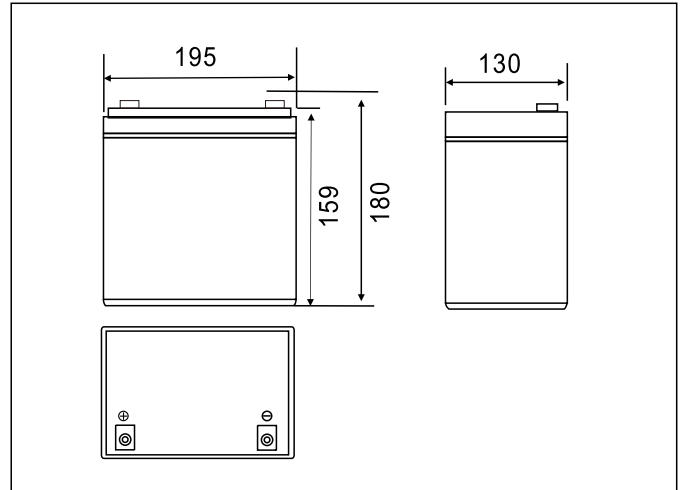

● Terminal Type (mm)

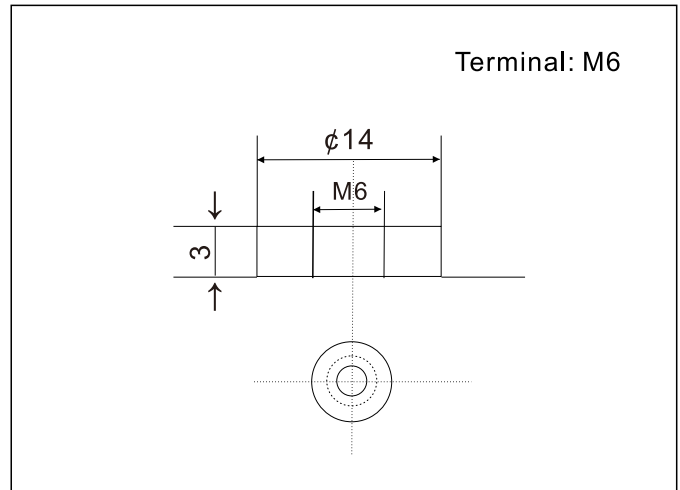

Constant Current(AMP) and Constant Power(Watt) Characteristics at 25°C(77°F)

Time		10min	15min	30min	1h	2h	3h	4h	5h	8h	10h	20h
9.60V	A	69.3	54.5	33.0	20.5	12.1	8.42	6.90	5.89	4.04	3.36	1.76
	w	748	598	370	233	140	99.0	81.1	69.6	48.0	40.4	21.2
9.90V	A	67.2	53.1	32.3	20.2	12.0	8.37	6.86	5.86	4.02	3.35	1.76
	w	726	584	363	230	139	98.4	80.7	69.2	47.7	40.0	21.1
10.20V	A	64.4	51.2	31.4	19.6	11.9	8.31	6.81	5.82	3.99	3.34	1.76
	w	696	562	352	224	138	97.7	80.1	68.7	47.4	39.9	21.1
10.50V	A	61.7	49.4	30.6	19.3	11.7	8.25	6.77	5.78	3.96	3.32	1.74
	w	666	543	343	219	136	97.0	79.6	68.3	47.0	39.7	20.9
10.80V	A	58.2	46.8	29.5	18.7	11.4	8.00	6.56	5.60	3.84	3.30	1.73
	w	629	514	331	213	132	94.1	77.2	66.2	45.6	39.4	20.8

● Discharge Characteristics(25°C)

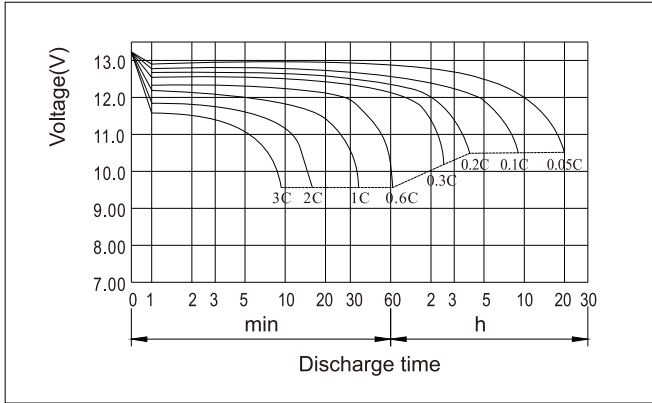

● Charging Characteristics(25°C)

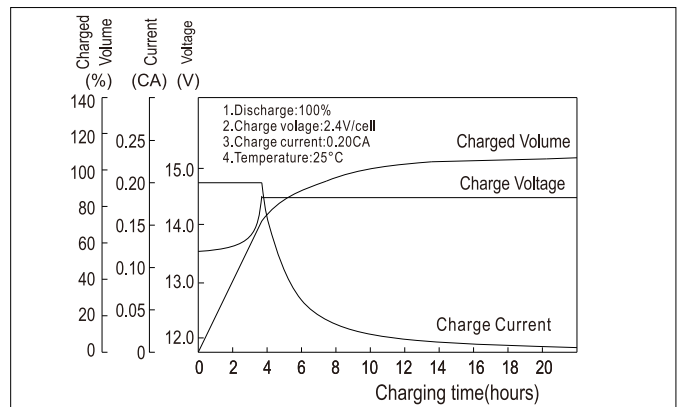

● Effect of Temperature on Capacity

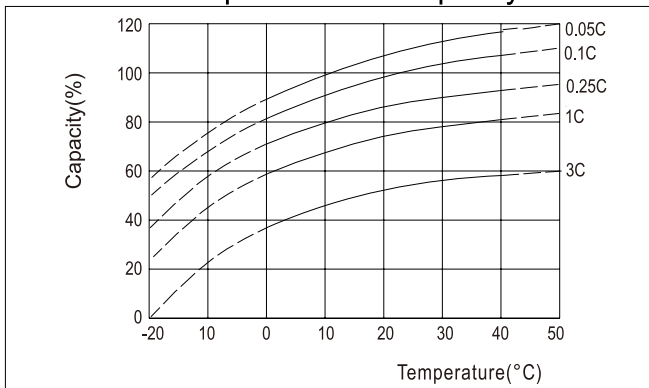

● Self-discharge Characteristics

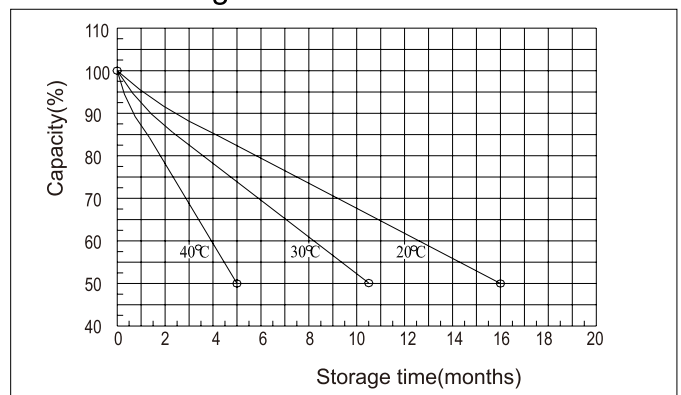

● The Relationship for Open Circuit Voltage and Residual Capacity (25°C)

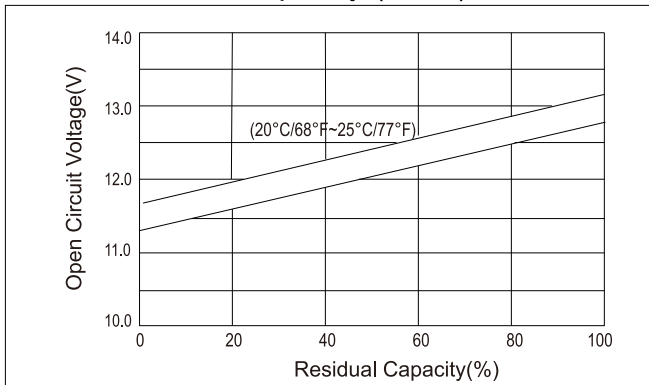

● The Relationship for Charging Voltage and Temperature

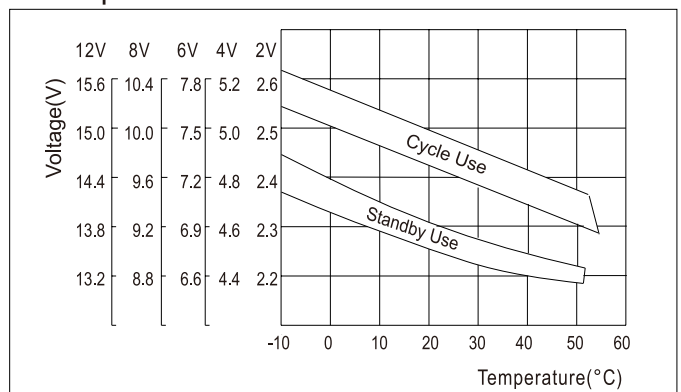

● Floating Life on Temperature

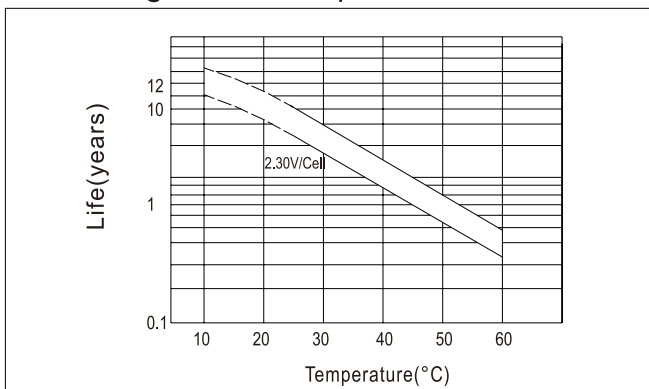

● Cycle Life on D.O.D (25°C)

