



● Specifications

Nominal Voltage		12V
Rated Capacity (20 hour rate)		24Ah
Dimensions	Total Height	175±2mm(6.89 inches)
	Height	175±2mm(6.89 inches)
	Length	166±2mm(6.54 inches)
	Width	125±2mm(4.92 inches)
Weight Approx		7.6kg(16.77 lbs)± 4%

● Characteristics

Capacity 25°C(77°F)	20 hour rate(1.20A)	24.0 AH
	10 hour rate(2.27A)	22.7 AH
	5 hour rate(4.16A)	20.8AH
	1hour rate(15.0A)	15.0 AH
Internal Resistance	Full charged Battery at 25°C(77°F)	14mΩ
Capacity affected by Temperature (20hour rate)	40°C(104°F)	102%
	25°C(77°F)	100%
	0°C(32°F)	85%
	-15°C(5°F)	65%
Self-Discharge at 25°C(77°F)	Capacity after 3 month storage	91%
	Capacity after 6 month storage	82%
	Capacity after 12 month storage	64%
Charge (constant voltage)	Cycle	Initial Charging Current Less than 7.2A Voltage 14.50-14.90V
	Float	Voltage 13.50-13.80V

● Applications

- Electric tools
- Electric toys
- Emergency lighting
- Electronic instruments
- Medical equipment
- Alarm and security systems
- Solar power systems
- Wind power systems
- Telecommunication equipments
- Uninterruptible power supplies

● Outer Dimensions (mm)

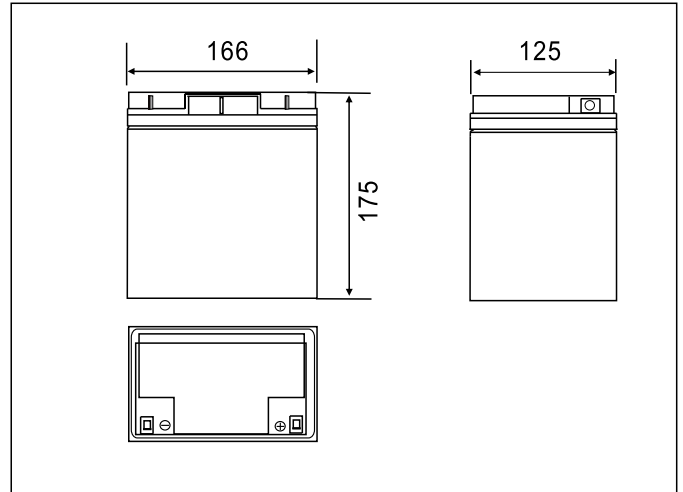

● Terminal Type (mm)

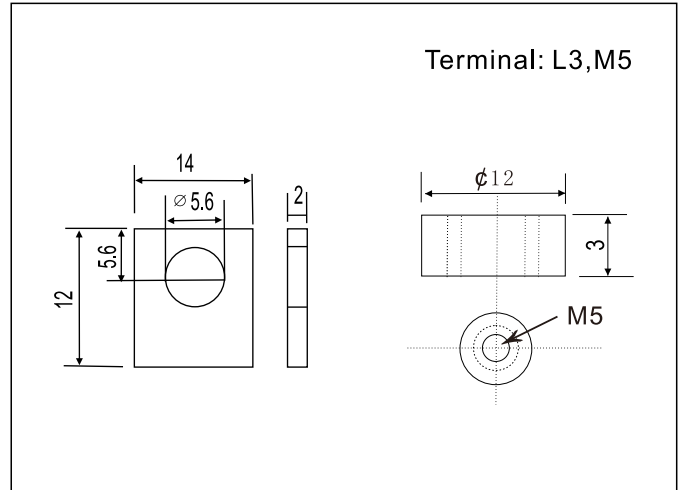

Constant Current(AMP) and Constant Power(Watt) Characteristics at 25°C(77°F)

F.V/TIME	10min	15min	30min	1h	2h	3h	4h	5h	8h	10h	20h
9.60V	A	55.2	43.7	24.4	15.0	8.53	6.12	4.90	4.16	2.69	1.22
	w	623	498	279	173	99.8	72.7	58.3	49.7	32.3	14.6
9.90V	A	53.5	42.7	23.9	14.7	8.48	6.08	4.87	4.14	2.68	1.21
	w	604	486	274	171	99.2	72.3	58.0	49.4	32.1	14.6
10.2V	A	51.3	41.1	23.2	14.4	8.40	6.04	4.83	4.11	2.66	1.21
	w	579	468	265	166	98.3	71.8	57.6	49.1	31.9	14.5
10.5V	A	49.1	39.7	22.6	14.1	8.27	6.00	4.80	4.08	2.64	1.20
	w	554	452	259	163	96.8	71.3	57.2	48.7	31.7	14.4
10.8V	A	46.4	37.6	21.8	13.6	8.06	5.82	4.66	3.96	2.56	1.18
	w	523	428	249	158	94.3	69.1	55.5	47.3	30.7	14.1

● Discharge Characteristics(25°C)

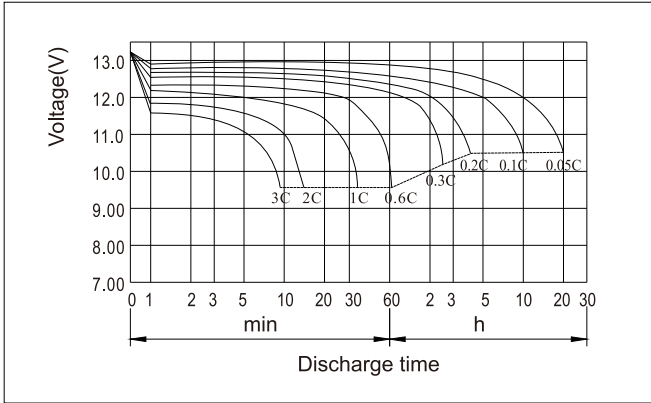

● Charging Characteristics(25°C)

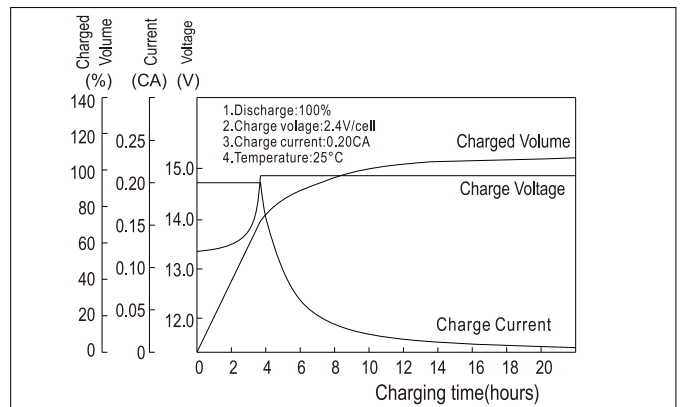

● Effect of Temperature on Capacity

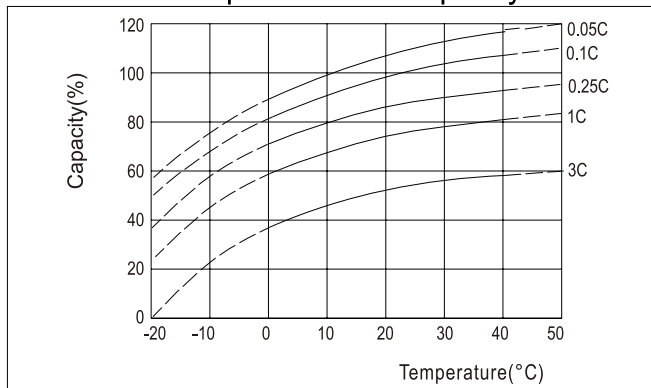

● Self-discharge Characteristics

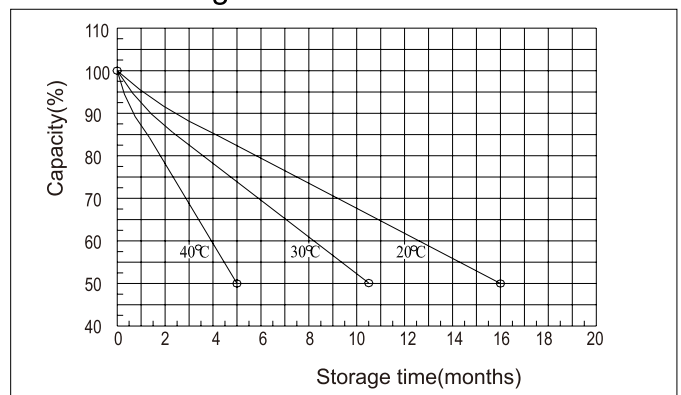

● The Relationship for Open Circuit Voltage and Residual Capacity (25°C)

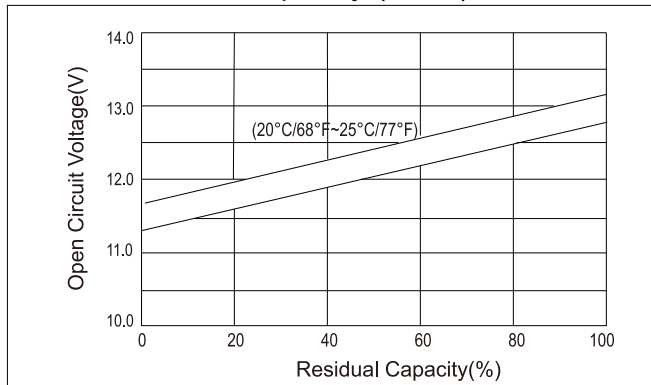

● The Relationship for Charging Voltage and Temperature

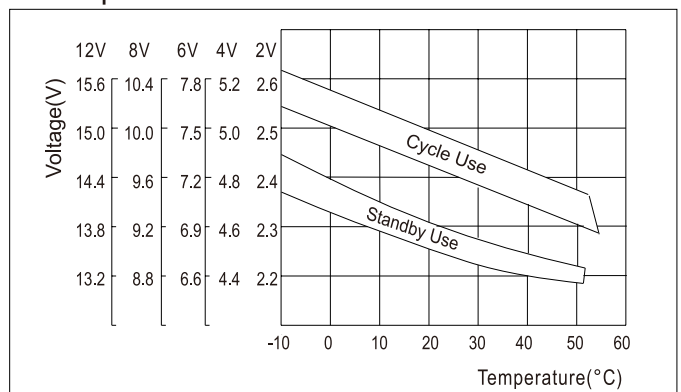

● Floating Life on Temperature

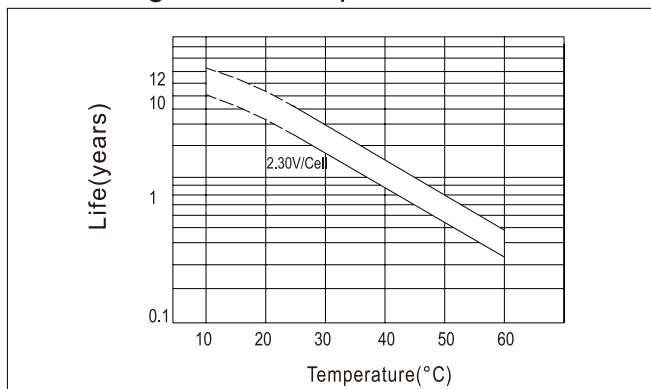

● Cycle Life on D.O.D (25°C)

