



Specifications

Nominal Voltage		12V
Rated Capacity (10 hour rate)		200Ah
Dimensions	Total Height	222±2mm(8.74 inches)
	Height	218±2mm(8.58 inches)
	Length	522±2mm(20.6 inches)
	Width	238±2mm(9.37 inches)
Weight Approx		59.5kg(131.19lbs)±4%

Characteristics

Capacity 25°C(77°F)	10 hour rate(20A)	200 AH
	5 hour rate(35A)	175 AH
	1hour rate(124A)	124AH
Internal Resistance	Full charged Battery at 25°C(77°F)	3m Ω
Capacity affected by Temperature (10hour rate)	40°C(104°F)	102%
	25°C(77°F)	100%
	0°C(32°F)	85%
	-15°C(5°F)	65%
Self-Discharge at 25°C(77°F)	Capacity after 3 month storage	91%
	Capacity after 6 month storage	82%
	Capacity after 12 month storage	64%
Charge (constant voltage)	Cycle	Initial Charging Current Less than 50 A Voltage 14.50-14.90V
	Float	Voltage 13.50-13.80V

Applications

- Electric tools
- Alarm and security systems
- Electric toys
- Solar power systems
- Emergency lighting
- Wind power systems
- Electronic instruments
- Telecommunication equipments
- Medical equipment
- Uninterruptible power supplies

Outer Dimensions (mm)

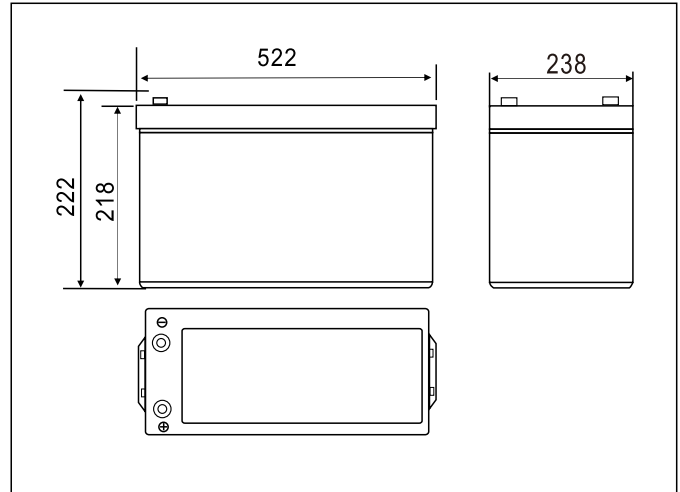

Terminal Type (mm)

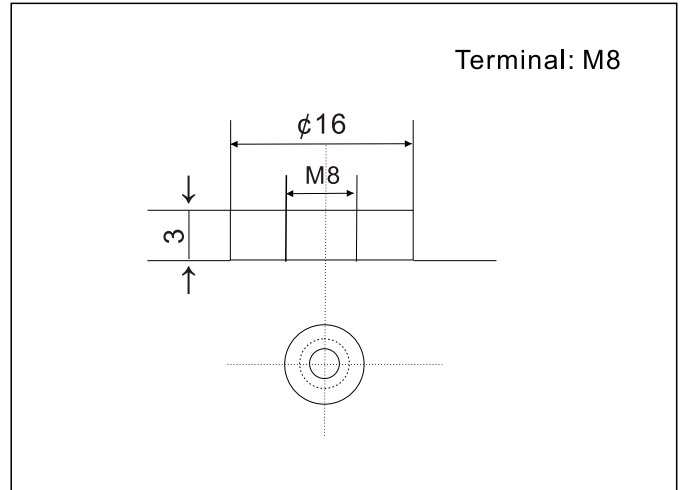

Constant Current(AMP) and Constant Power(Watt) Characteristics at 25°C(77°F)

F.V/TIME	15min	30min	1h	2h	3h	4h	5h	6h	8h	10h	20h
9.60V	A	333	202	125	73.1	51.0	41.8	35.7	31.2	24.5	10.7
	w	3660	2266	1428	846	600	492	422	369	291	128
9.90V	A	325	198	123	72.6	50.7	41.6	35.5	31.0	24.3	10.7
	w	3572	2221	1406	841	596	489	419	367	289	128
10.20V	A	313	192	120	72.0	50.4	41.3	35.2	30.8	24.2	10.6
	w	3440	2153	1371	834	592	486	417	364	287	128
10.50V	A	303	187	118	70.9	50.0	41.0	35.0	30.6	24.0	10.6
	w	3323	2101	1343	821	588	482	414	362	285	127
10.80V	A	287	180	114	69.1	48.5	39.8	34.0	29.7	23.3	10.5
	w	3147	2002	1302	800	570	468	401	351	277	126

● Discharge Characteristics(25°C)

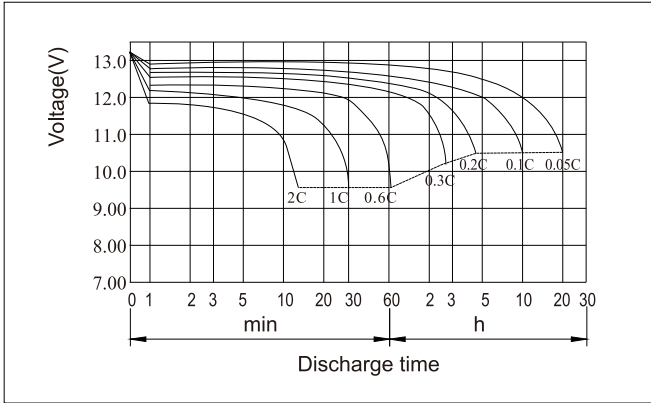

● Charging Characteristics(25°C)

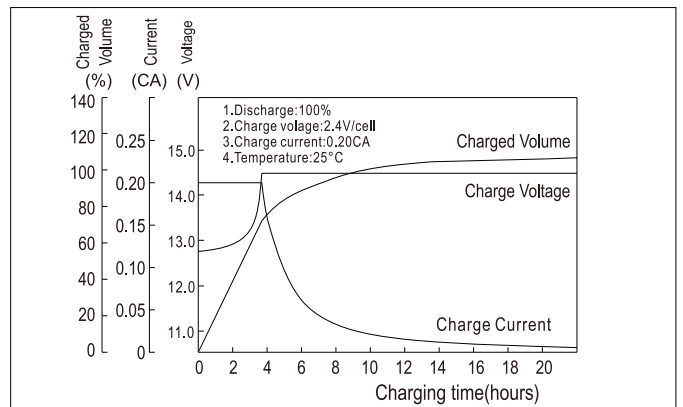

● Effect of Temperature on Capacity

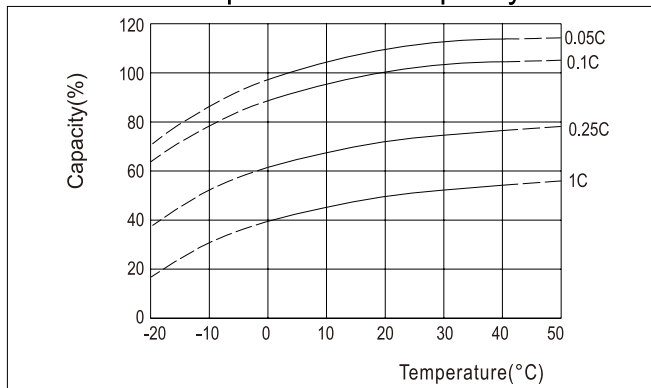

● Self-discharge Characteristics

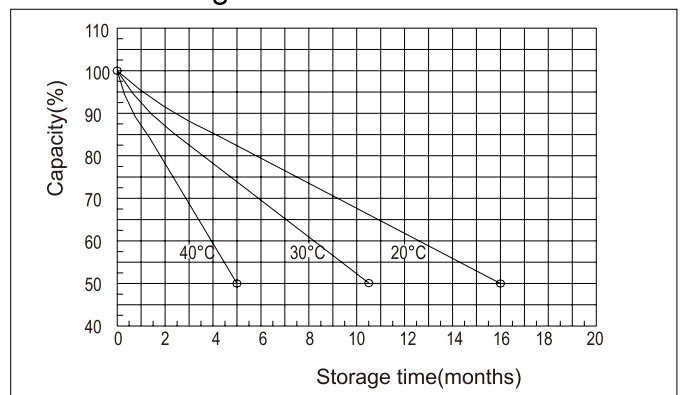

● The Relationship for Open Circuit Voltage and Residual Capacity (25°C)

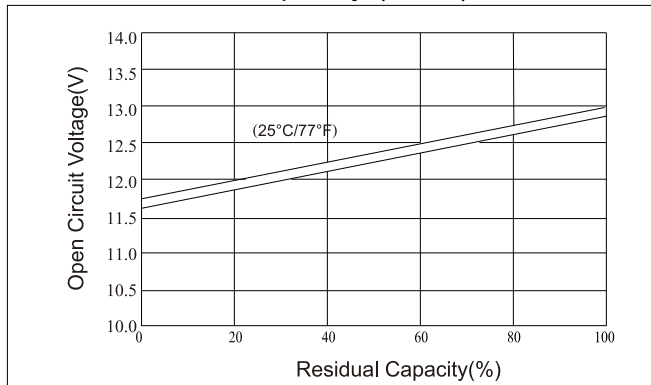

● The Relationship for Charging Voltage and Temperature

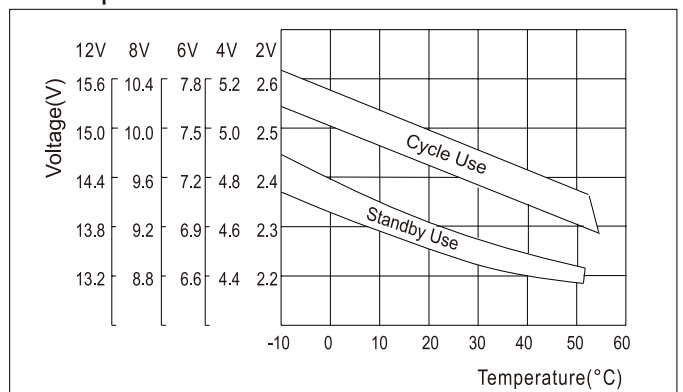

● Floating Life on Temperature

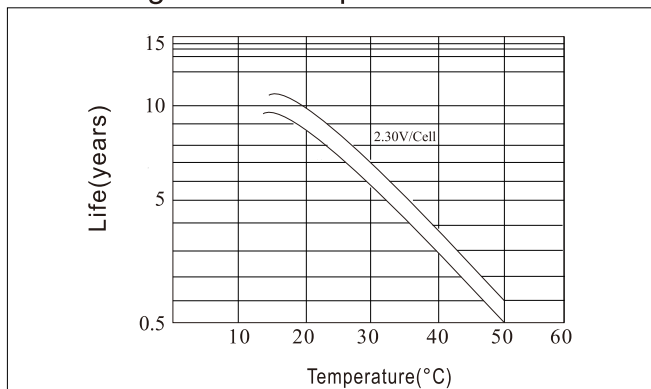

● Cycle Life on D.O.D (25°C)

