



Specifications

Nominal Voltage		12V
Rated Capacity (10 hour rate)		150Ah
Dimensions	Total Height	240±2mm(9.45 inches)
	Height	240±2mm(9.45 inches)
	Length	483±2mm(19.0 inches)
	Width	170±2mm(6.69 inches)
Weight Approx		40kg(92.61 lbs)±4%

Characteristics

Capacity 25°C(77°F)	10 hour rate(15A) 5 hour rate(26A) 1 hour rate(93A)	150 AH 130 AH 93AH
Internal Resistance	Full charged Battery at 25°C(77°F)	3.5m Ω
Capacity affected by Temperature (10hour rate)	40°C(104°F) 25°C(77°F) 0°C(32°F) -15°C(5°F)	102% 100% 85% 65%
Self-Discharge at 25°C(77°F)	Capacity after 3 month storage Capacity after 6 month storage Capacity after 12 month storage	91% 82% 64%
Charge (constant voltage)	Cycle	Initial Charging Current Less than 37.5 A Voltage 14.50-14.90V
	Float	Voltage 13.50-13.80V

Applications

- Electric tools
- Electric toys
- Emergency lighting
- Electronic instruments
- Medical equipment
- Alarm and security systems
- Solar power systems
- Wind power systems
- Telecommunication equipments
- Uninterruptible power supplies

Outer Dimensions (mm)

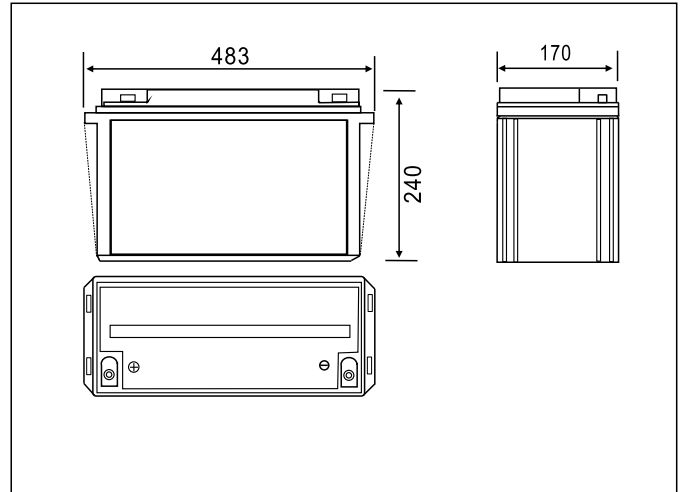

Terminal Type (mm)

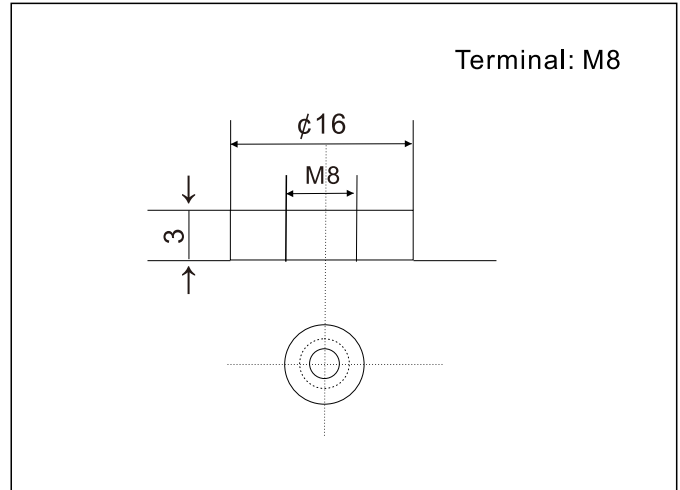

Constant Current(AMP) and Constant Power(Watt) Discharge Table at 25°C(77°F)

Time	15min	30min	1h	2h	3h	4h	5h	6h	8h	10h	20h
9.60V	A	248	150	93.0	54.8	38.3	31.4	26.8	23.4	18.4	8.02
	w	2718	1683	1060	638	450	369	316	277	218	96.2
9.90V	A	242	147	91.6	54.5	38.0	31.2	26.6	23.3	18.3	8.00
	w	2652	1649	1044	631	447	367	315	275	217	96.0
10.20V	A	233	143	89.3	54.0	37.8	31.0	26.4	23.1	18.1	7.98
	w	2554	1599	1018	625	444	364	312	273	215	95.7
10.50V	A	225	139	87.5	53.2	37.5	30.8	26.3	23.0	18.0	7.93
	w	2468	1560	998	616	441	362	312	271	214	95.2
10.80V	A	213	134	84.8	51.8	36.4	39.8	25.5	22.3	17.5	7.88
	w	2337	1503	967	600	428	351	301	263	207	94.5

● Discharge Characteristics(25°C)

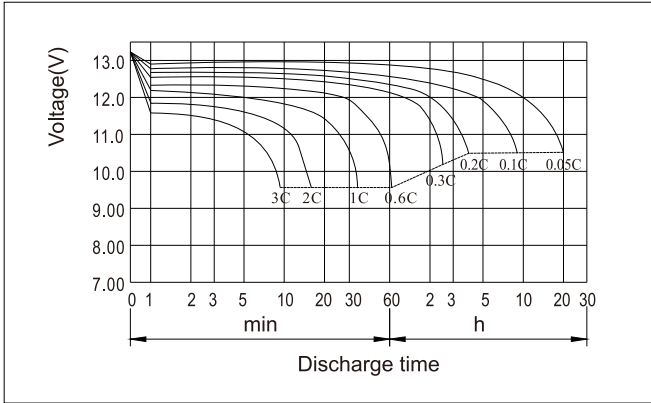

● Charging Characteristics(25°C)

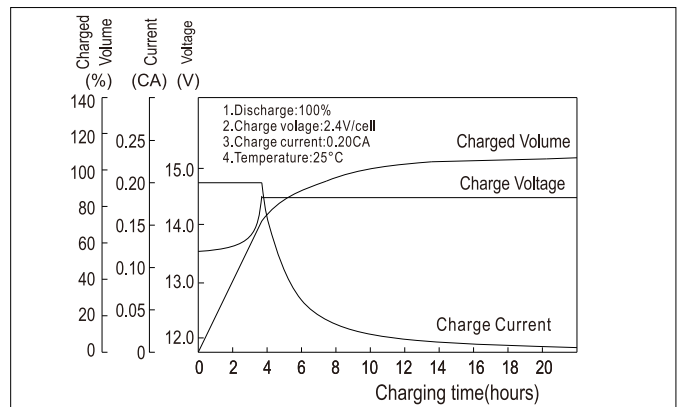

● Effect of Temperature on Capacity

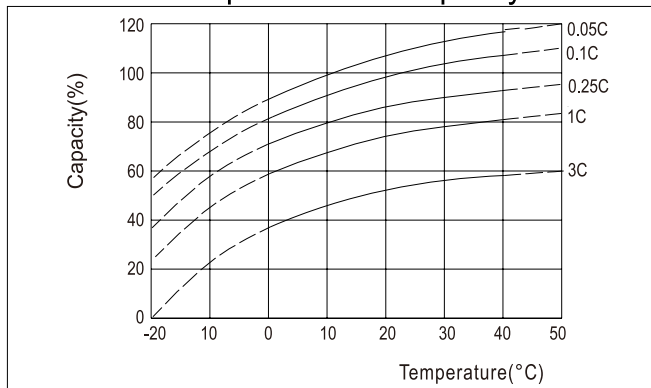

● Self-discharge Characteristics

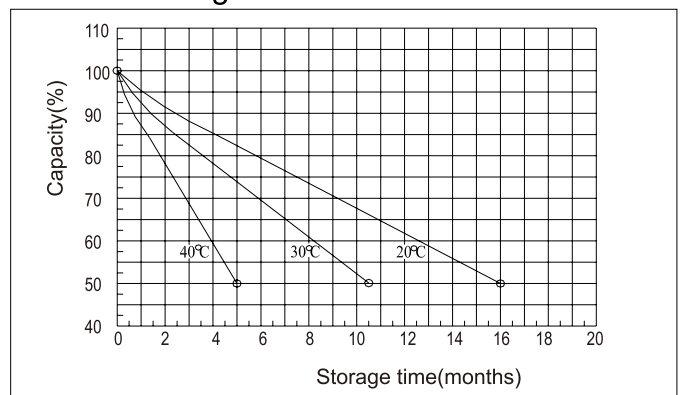

● The Relationship for Open Circuit Voltage and Residual Capacity (25°C)

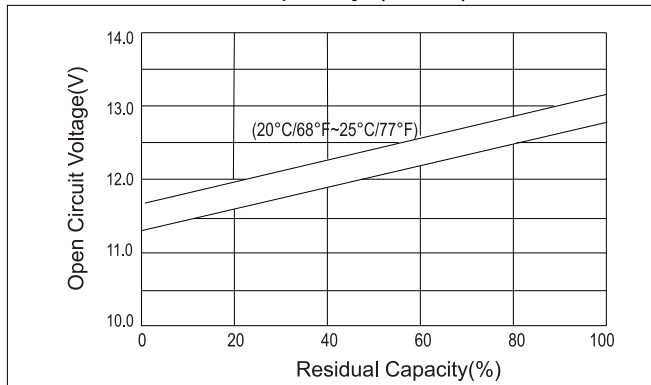

● The Relationship for Charging Voltage and Temperature

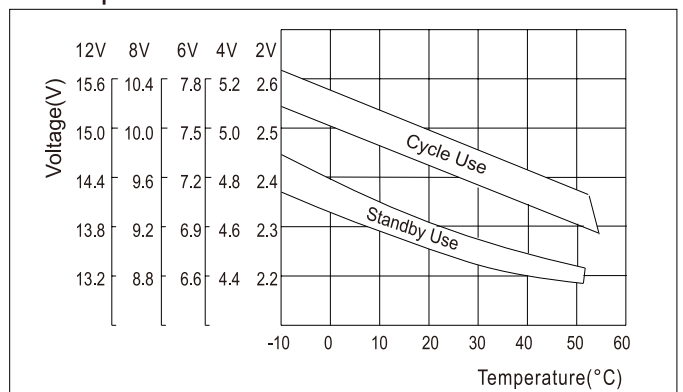

● Floating Life on Temperature

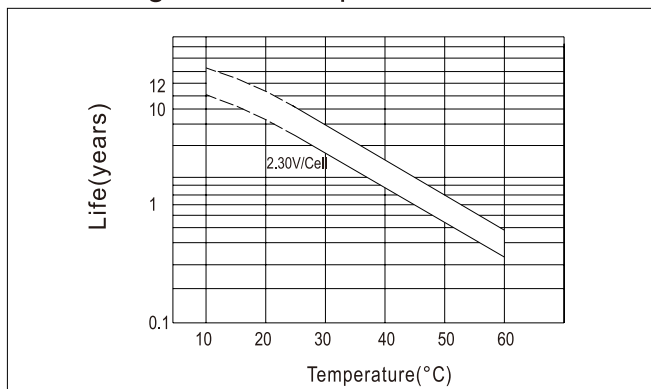

● Cycle Life on D.O.D (25°C)

