



Specifications

Nominal Voltage		12V
Rated Capacity (10 hour rate)		180Ah
Dimensions	Total Height	222±2mm(8.74 inches)
	Height	218±2mm(8.58 inches)
	Length	522±2mm(20.6 inches)
	Width	238±2mm(9.37 inches)
Weight Approx		54kg(112.1lbs)±4%

Characteristics

Capacity 25°C(77°F)	10 hour rate(18A)	180 AH
	5 hour rate(32A)	160 AH
	1hour rate(112A)	112AH
Internal Resistance	Full charged Battery at 25°C(77°F)	3.3mΩ
Capacity affected by Temperature (10hour rate)	40°C(104°F)	102%
	25°C(77°F)	100%
	0°C(32°F)	85%
	-15°C(5°F)	65%
Self-Discharge at 25°C(77°F)	Capacity after 3 month storage	91%
	Capacity after 6 month storage	82%
	Capacity after 12 month storage	64%
Charge (constant voltage)	Cycle	Initial Charging Current Less than 45 A Voltage 14.50-14.90V
	Float	Voltage 13.50-13.80V

Applications

- Electric tools
- Electric toys
- Emergency lighting
- Electronic instruments
- Medical equipment
- Alarm and security systems
- Solar power systems
- Wind power systems
- Telecommunication equipments
- Uninterruptible power supplies

Outer Dimensions (mm)

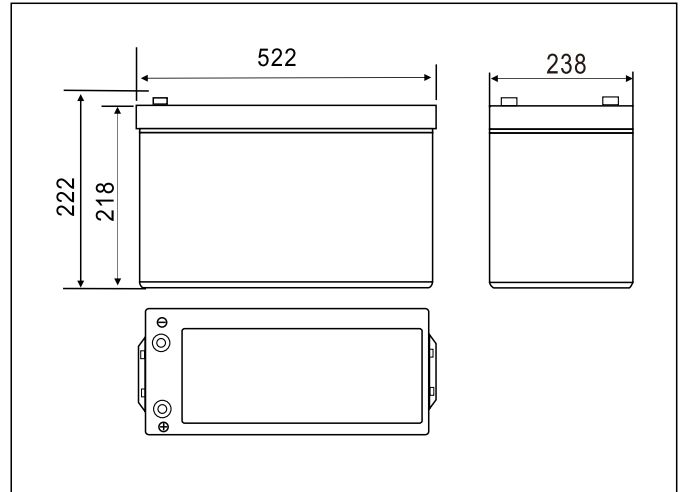

Terminal Type (mm)

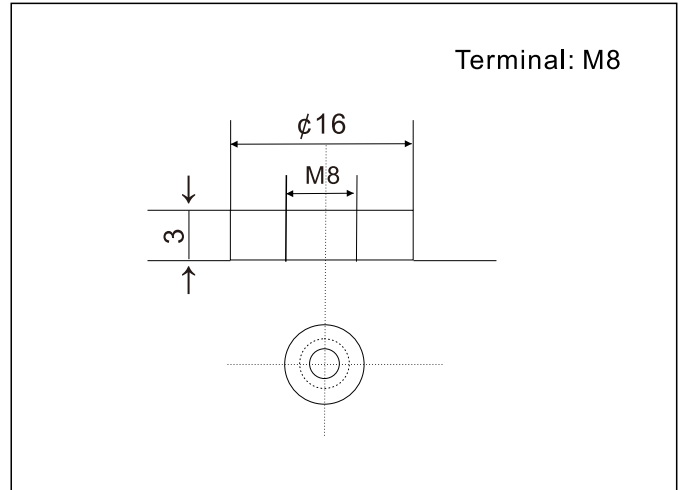

Constant Current(AMP) and Constant Power(Watt) Discharge Table at 25°C(77°F)

Time	15min	30min	1h	2h	3h	4h	5h	6h	8h	10h	20h	
9.60V	A	297	180	112	65.8	45.9	37.6	32.1	28.1	22.0	18.3	9.62
	w	3261	2020	1272	762	540	443	380	332	262	219	115
9.90V	A	290	176	110	65.4	45.6	37.4	31.9	27.9	21.9	18.3	9.60
	w	3183	1979	1253	757	537	440	378	330	260	218	115
10.20V	A	279	171	107	64.8	45.3	37.2	31.7	27.7	21.8	18.2	9.57
	w	3065	1919	1221	750	533	437	375	328	258	218	115
10.50V	A	270	167	105	63.8	45.0	36.9	31.5	27.5	21.6	18.1	9.52
	w	2961	1872	1197	739	529	434	372	326	257	216	114
10.80V	A	255	161	102	62.2	43.7	35.8	30.6	26.7	21.0	18.0	9.45
	w	2805	1804	1160	720	513	421	361	316	249	215	113

● Discharge Characteristics(25°C)

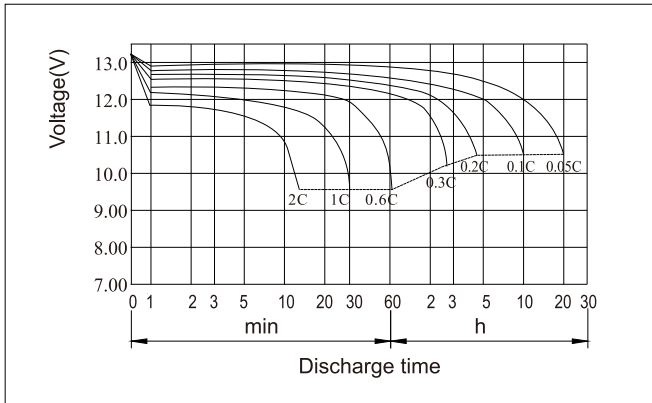

● Charging Characteristics(25°C)

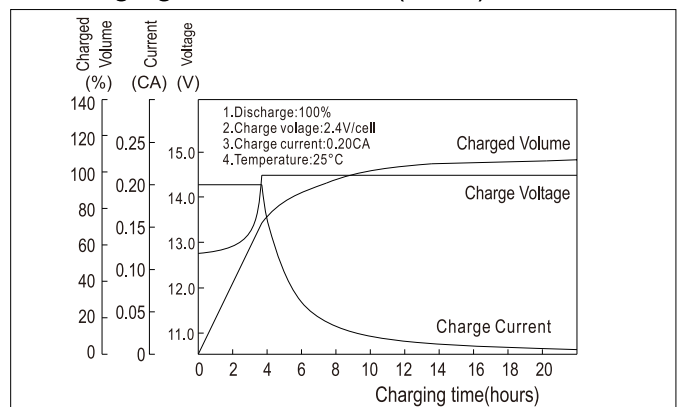

● Effect of Temperature on Capacity

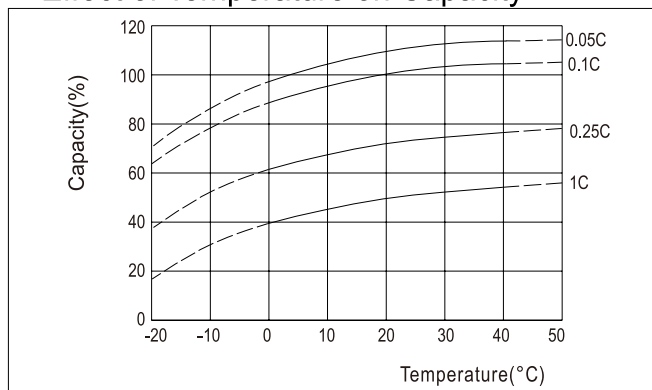

● Self-discharge Characteristics

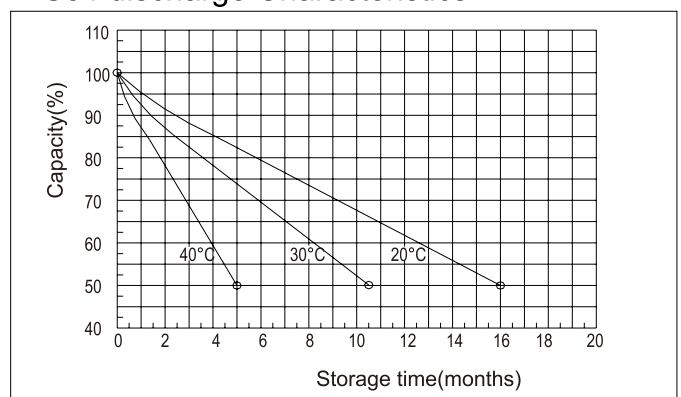

● The Relationship for Open Circuit Voltage and Residual Capacity (25°C)

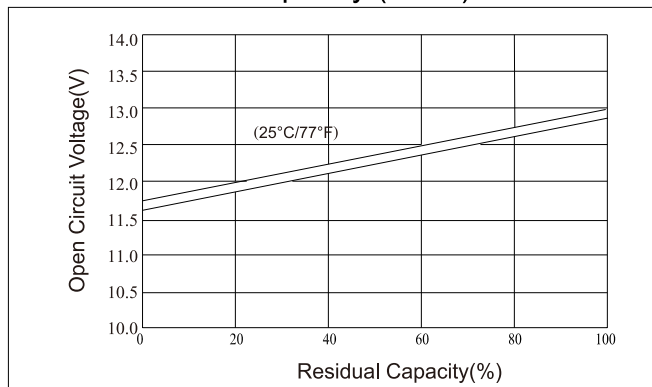

● The Relationship for Charging Voltage and Temperature

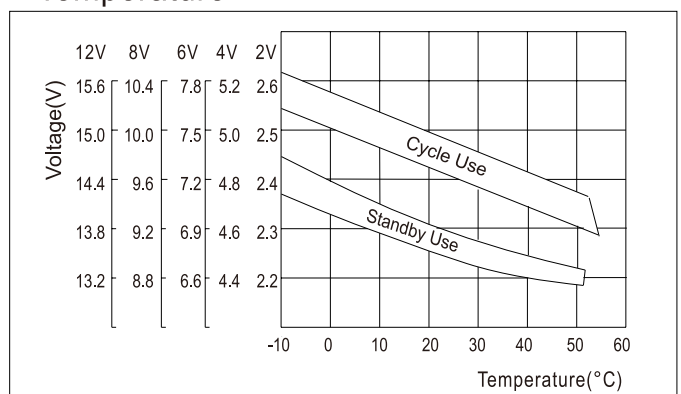

● Floating Life on Temperature

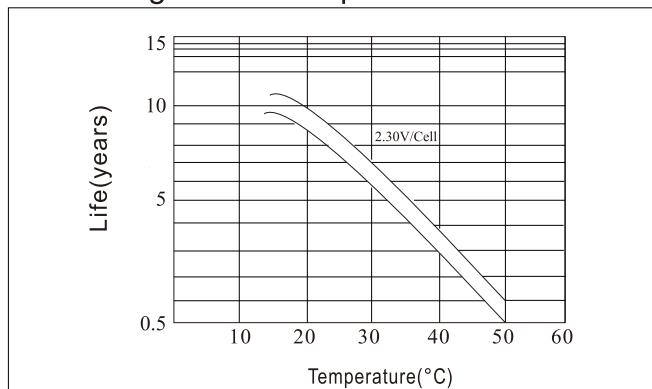

● Cycle Life on D.O.D (25°C)

