



● Applications

- Electric tools
- Electric toys
- Emergency lighting
- Electronic instruments
- Medical equipment
- Alarm and security systems
- Solar power systems
- Wind power systems
- Telecommunication equipments
- Uninterruptible power supplies

● Specifications

Nominal Voltage		12V
Rated Capacity (10 hour rate)		100Ah
Dimensions	Total Height	218±2mm(8.58inches)
	Height	214±2mm(8.43 inches)
	Length	330±2mm(13.0 inches)
	Width	171±2mm(6.73 inches)
Weight Approx		30.5kg(64.21 lbs)±4%

● Outer Dimensions (mm)

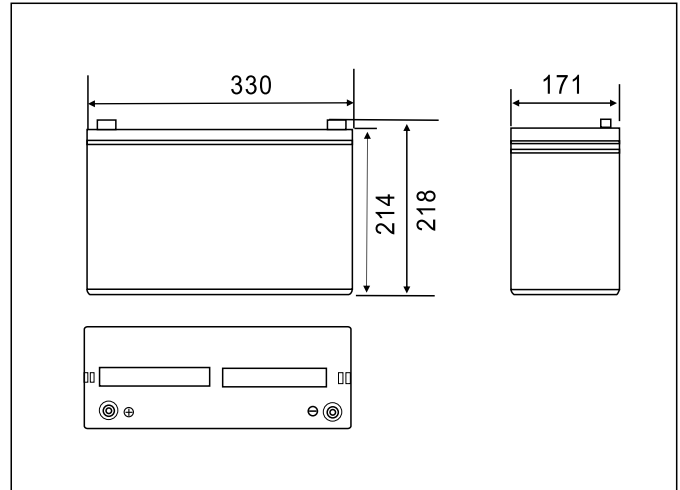

● Characteristics

Capacity 25°C(77°F)	10 hour rate(11A) 5 hour rate(19.6A) 1hour rate(71A)	110 AH 98 AH 71AH
Internal Resistance	Full charged Battery at 25°C(77°F)	3.5m Ω
Capacity affected by Temperature (10hour rate)	40°C(104°F) 25°C(77°F) 0°C(32°F) -15°C(5°F)	102% 100% 85% 65%
Self-Discharge at 25°C(77°F)	Capacity after 3 month storage Capacity after 6 month storage Capacity after 12 month storage	91% 82% 64%
Charge (constant voltage)	Cycle	Initial Charging Current Less than 25 A Voltage 14.50-14.90V
	Float	Voltage 13.50-13.80V

● Terminal Type (mm)

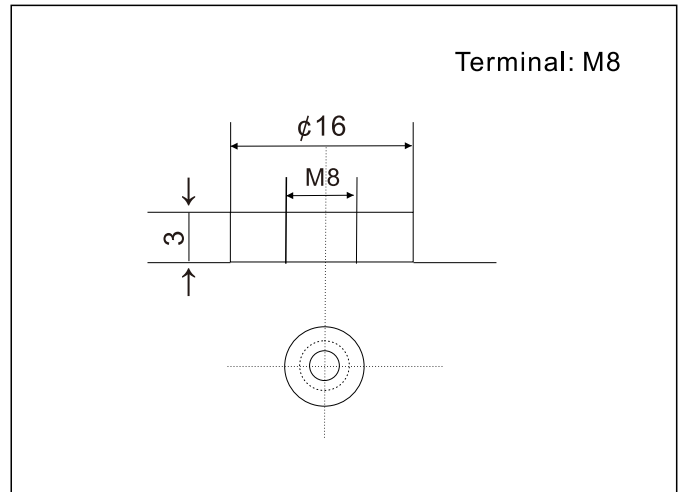

Constant Current(AMP) and Constant Power(Watt) Discharge Table at 25°C(77°F)

Time		15min	30min	1h	2h	3h	4h	5h	6h	8h	10h	20h	48h	120h
9.60V	A	149	103	64.0	37.4	26.4	20.8	17.4	14.9	11.6	10.3	5.62	—	—
	w	1507	1062	670	396	283	223	188	160	125	112	61.6	—	—
9.90V	A	145	100	63.0	37.2	26.2	20.7	17.3	14.7	11.4	10.3	5.61	—	—
	w	1470	1041	660	393	282	222	187	159	125	112	61.5	—	—
10.20V	A	140	97.4	61.5	36.9	26.1	20.5	17.2	14.6	11.4	10.3	5.60	2.23	—
	w	1416	1009	644	390	280	220	185	158	124	112	61.3	26.8	—
10.50V	A	135	95.0	60.3	36.3	25.9	20.4	17.1	14.5	11.3	10.2	5.50	2.44	1.01
	w	1368	985	631	384	278	219	184	157	123	111	60.3	26.6	11.1
10.80V	A	128	91.5	58.4	35.4	25.1	19.7	16.5	14.1	11.0	10.1	5.50	2.44	1.01
	w	1296	949	611	374	269	212	179	152	119	110	60.5	26.6	11.0

● Discharge Characteristics(25°C)

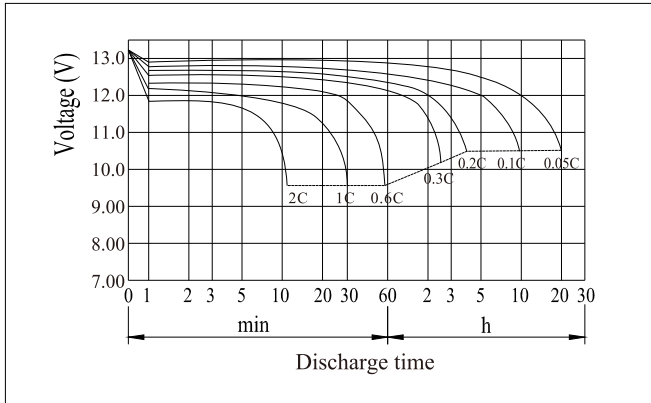

● Charging Characteristics(25°C)

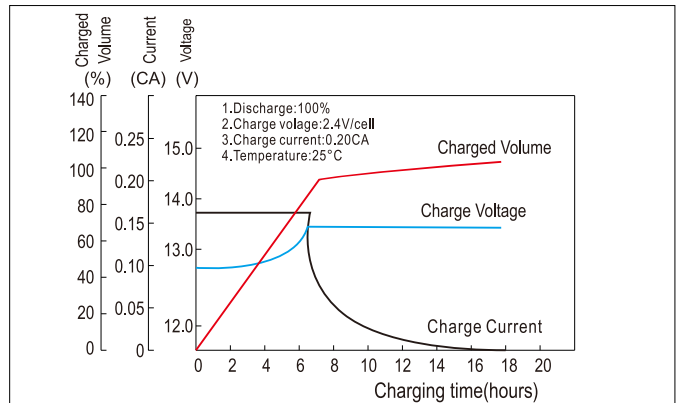

● Effect of Temperature on Capacity

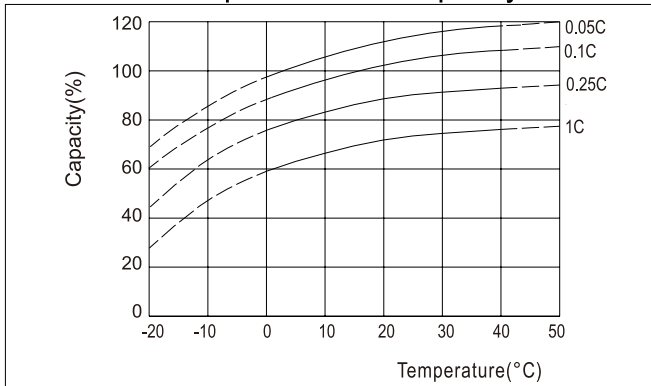

● Self-discharge Characteristics

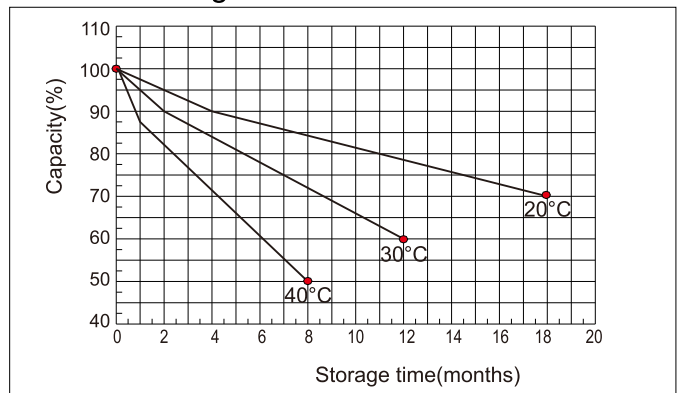

● The Relationship for Open Circuit Voltage and Residual Capacity (25°C)

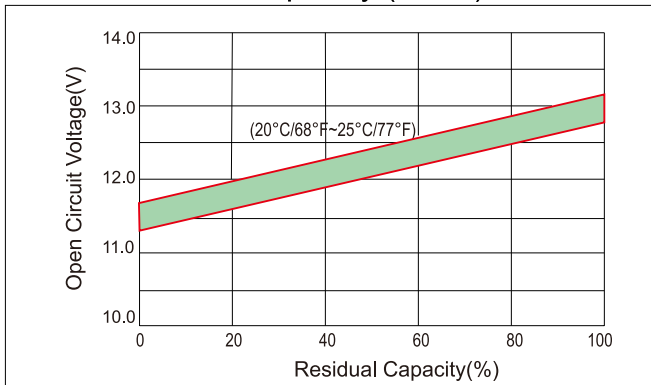

● The Relationship for Charging Voltage and Temperature

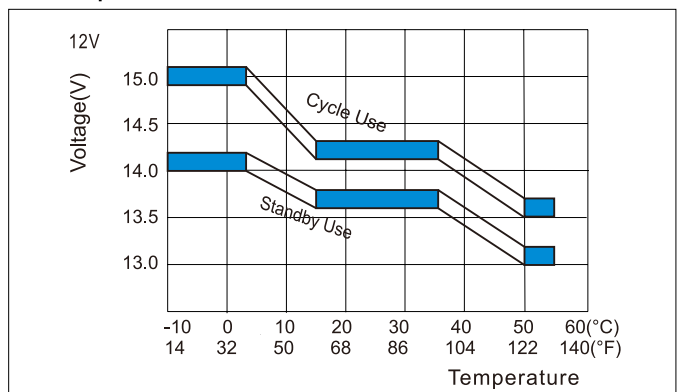

● Floating Life on Temperature

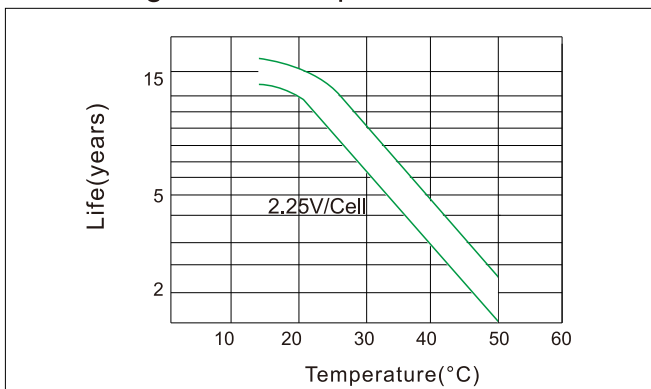

● Cycle Life on D.O.D (25°C)

